



中国电源学会第二十三届学术年会

The 23rd China Power Supply Society Conference (CPSSC'2019)

2019年11月1日至4日

地点: 深圳



纳微 Navitas

Let's go GaNFast™





谢谢，恭喜

GaNFast™



- 谢谢
 - Navitas Diamond Sponsorship Award
 - CPSS-PSMA Workshop
- 恭喜
 - Successful CPSSC 2019



纳微半导体



GaNFast™

- 全世界首家氮化镓功率芯片
 - 获JEDEC认证
 - 量产并快速增量
- Navitas: 拉丁文即“能量”
 - 为电力电子行业注入新能量
- 2014年成立
 - 总部: 美国加州洛杉矶El Segundo, USA
- 世界级管理团队
 - 70多位雇员
- 世界级制造商合作伙伴
 - 晶圆厂: 台积电(TSMC)
 - 封装厂: 安靠(Amkor)
- 强大的投资人团队
 - 管理资本超过10亿美金

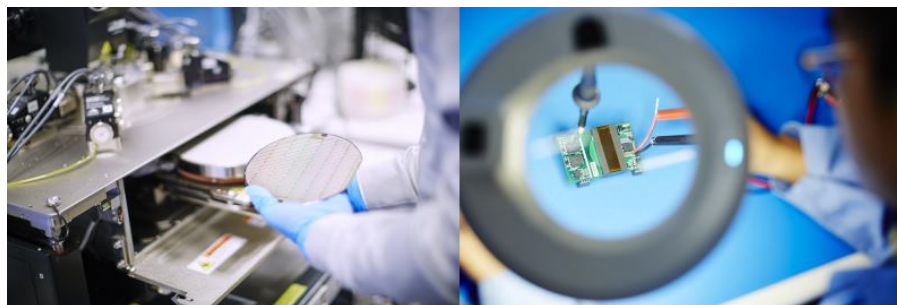

navitas
noun | en·er·gy





屏幕更大， 电池更大... 5G?



2007
Apple
iPhone 1
36.5 cm²
1,400 mAh



2013
Samsung
Galaxy S4
68.9 cm²
2,600 mAh



2019
Huawei
Mate X
205 cm²
4,500 mAh

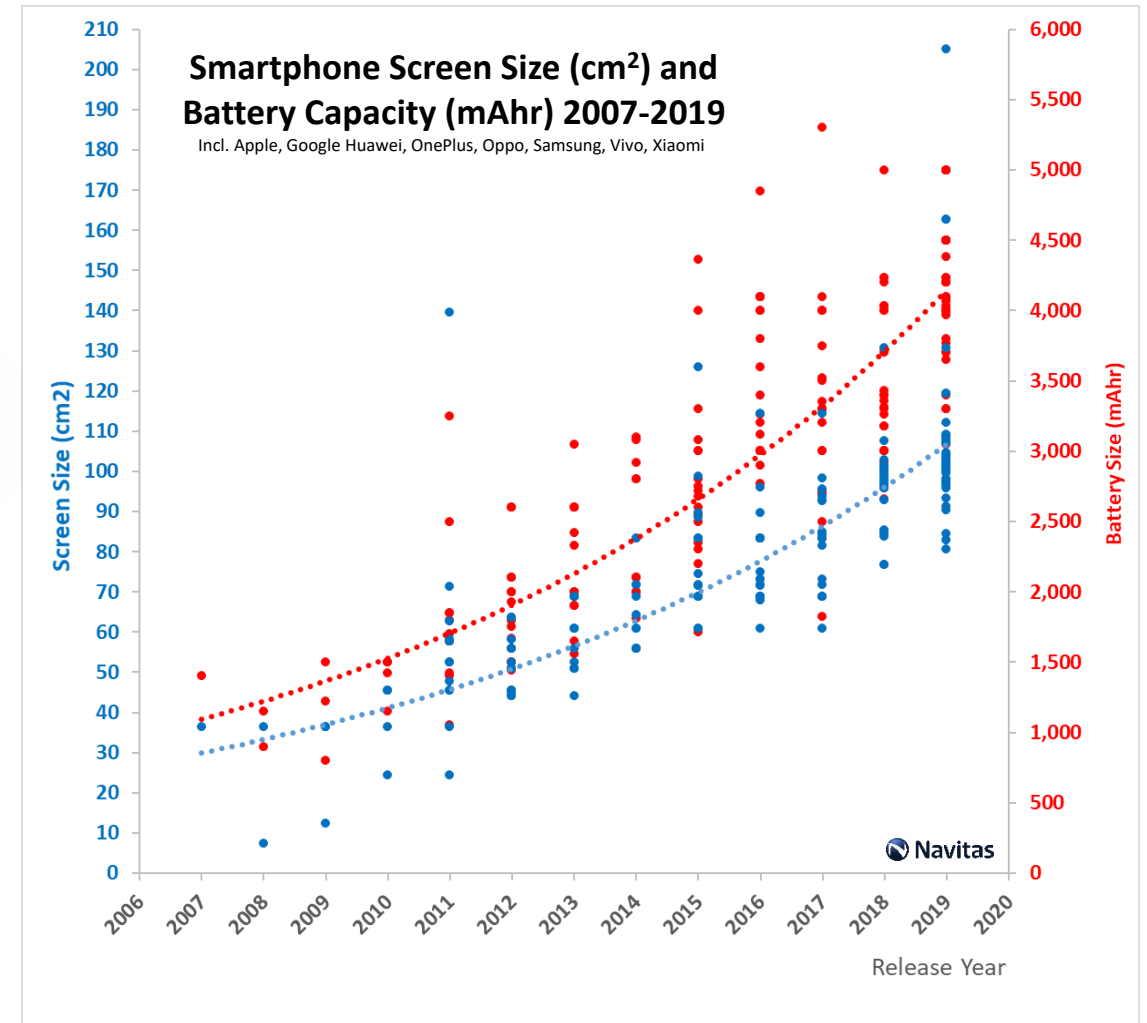

2019 = 1.4B Smartphones



更大的功率和更快的充电



Vivo's Super FlashCharge 120W technology, claims 100% charge of a 4,000 mAh battery in just 13 minutes.

OEM Charger Power 2019

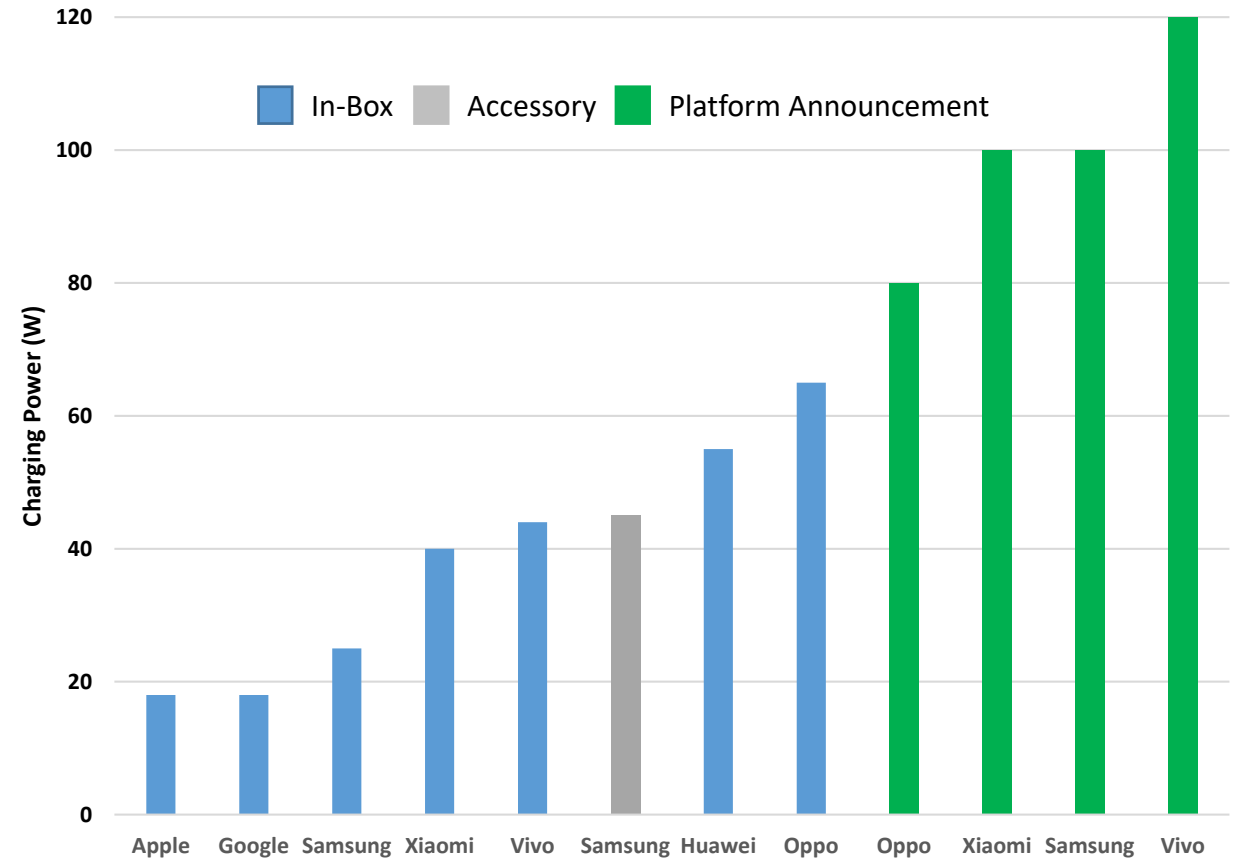



引领大功率手机快充: GaN技术



GaN replaces silicon, electrifies applications around the world

GaN Speed
GaN Efficiency
GaN Density

Ga 31 Gallium
N 7 Nitrogen

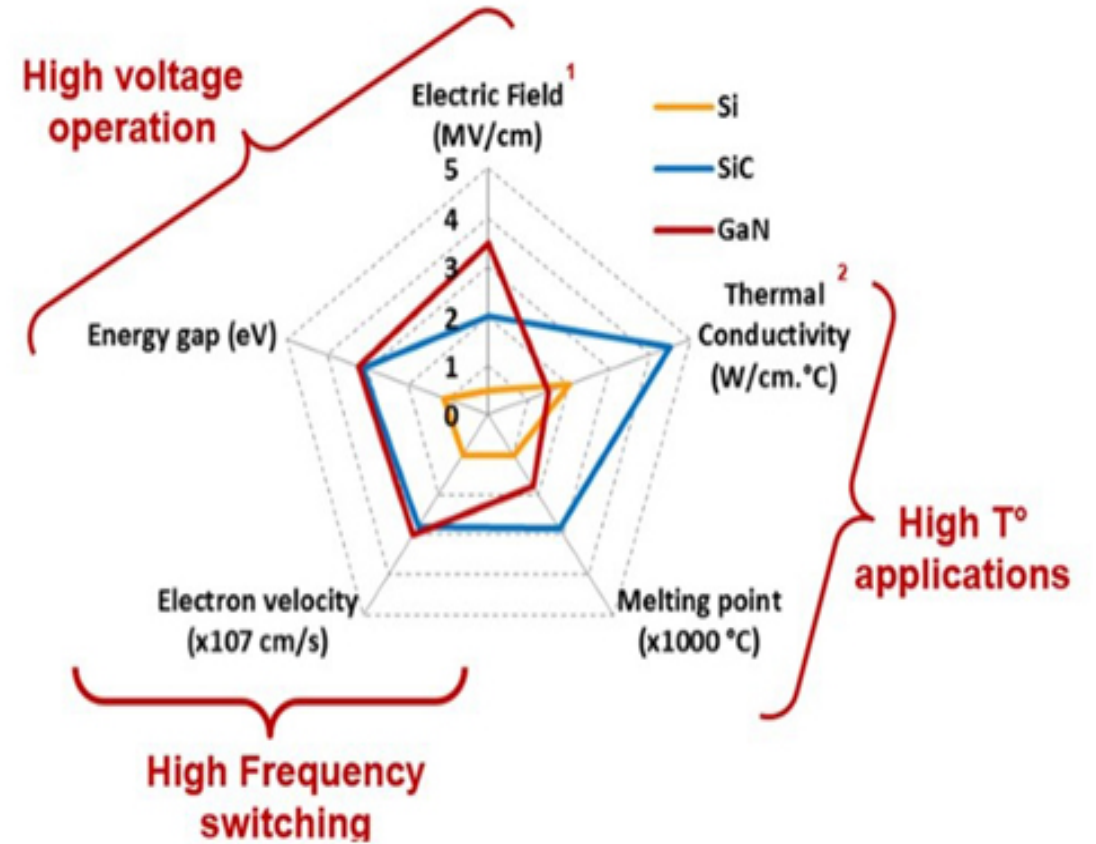



全世界首款

GaNFast™ 功率IC

GaNFast™

最快, 最高效的GaN功率管

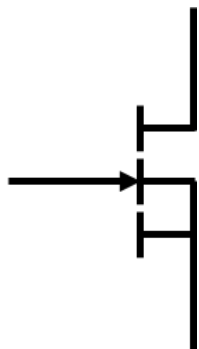

专有设计

速度高于硅器件20倍以上

速度高于cascoed GaN 5倍以上

首个&最快速集成的GaN 门极驱动器

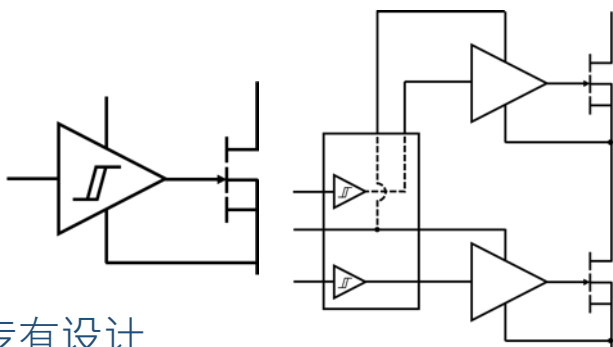

专有设计

速度高于所有门极驱动器3倍以上

获颁或正在申请的专利超过 75 项

全世界第一款

GaNFast™ 功率 IC

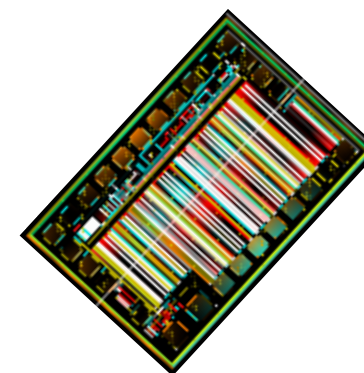

支持高达40MHz开关频率, 5倍以上功率密度, 系统成本降低20%



商业量产案例 GaNFast Chargers Are Here!

Fast

Up to 3x more power
Up to 3x faster charging

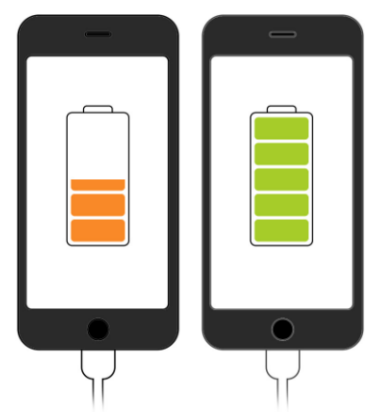

Mobile

Half the size & weight
of traditional chargers



Universal

One charger for **ALL** your devices
One and Done!!



Macbook 12" | iPhone XS | Nintendo Switch
Dell XPS 15/13 | Google Pixel 2 | And more...

Flexible

Charger **and** battery pack,
and multiple outputs



AUKEY

MADE IN MIND

RAVPOWER®

ANKER Apple Store



27W

24W

30W



45W



45W

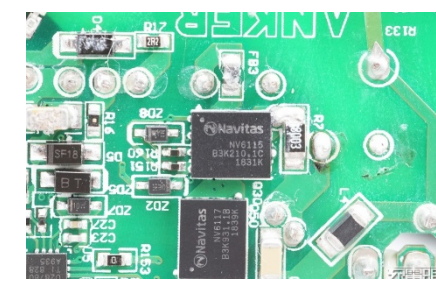

42W (30W-C + 18W-A)
+ 5,000 mAh

Design = Apple + Anker + Navitas



更大的功率和更小的尺寸

GaNFast™



Apple Si 18W
42 x 41 x 27 mm
= 47 cc, 60 g
(fixed AC pins)

AUKEY 27W
36 x 36 x 32 mm
= 41.5 cc, 45 g

70% more Power for Size
(1.7x W/cc)



Apple Si 61W
73 x 73 x 28 mm
= 149 cc, 193 g

EGGTRONIC 65W
68 x 50 x 19 mm
= 65 cc, 90 g

140% more Power for Size
(2.4x W/cc)



超级轻便

65W 3-in-1 快充, 更小(1/3), 更轻

GaNFast™

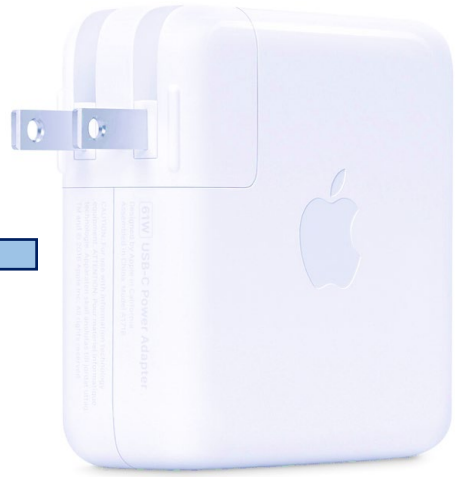

Apple Si 18W
42 x 41 x 27 mm
= 47 cc, 60 g
(fixed AC pins)

Apple Si 30W
55.9 x 55.9 x 32 mm
= 87.2 cc, 158 g

Apple Si 61W
73 x 73 x 28 mm
= 149 cc, 193 g

B Baseus GaN 65W
75 x 35 x 32 mm
= 84 cc, 125 g

USB-C #1 up to 65W
USB-C #2 up to 30W
USB-A up to 30W



业界最小300W手提电脑充电器



业界最快手提电脑：
Asus ProArt StudioBook One
NVIDIA Quadro RTX™ 6000





*Here come the
GaN chargers*